



FIRE & CO SAFETY EXPERTS



CONTRACTORS' GUIDEBOOK



espireuk.com

We are Espire®

The brand offers a wide range of cutting-edge safety alarms that meet and exceed industry standards. Espire® is committed to equipping homes with trusted and reliable alarms to provide for early detection and rapid response to potential threats.

A brand by ESP®

ESP's strong distribution network and commitment to excellence ensure that Espire's safety alarms are readily available to all customers, backed by exceptional customer service and support.

Part of Scolmore® Group

Developed by the esteemed Scolmore® Group, a renowned leader in electrical and lighting solutions, Espire® combines innovation, reliability, and the backing of a trusted industry partner.



Welcome

Scolmore® Group is proud to present Espire®, a Fire & CO safety brand committed to harnessing the very latest technologies, and developing superior performing products which allow installation projects to be completed quickly and easily.

Scolmore®
●●●●● GROUP



Your safety, **our priority.**

Our contractors' guidebook includes important information for fire and CO installations for residential applications.



Why Choose Espire®?

To support contractors', Espire® alarms are simple to install, saving you time.

Our outstanding product range is guaranteed to have precisely what you need in terms of fire and carbon monoxide protection.



Our guidebook covers all the essential information you need to know. However, if you have any questions, our dedicated technical support team is here to assist you. Feel free to reach out to us on 01527 515 150, and we will be delighted to provide the support you need.

Tried & Tested Products

Our alarms are of the highest quality and have all the relevant certifications - providing assurance that our products and services will always meet the requirements of specified standards, when installed in accordance with the manufacturer's instructions.



For additional peace of mind, the Espire® range of fire and CO safety products has been tested to the relevant standards and is certified by the Loss Prevention Certification Board and TUV.

The Espire® range is from ESP®, FIA registered.

ESP® has been present in the UK fire and security market for over 25 years - with a dedicated customer service and technical support team on hand to provide the best in before and after sales support.



Training and Support

Training Days

Our product overview training days are aimed at electrical contractors' and wholesalers who would like to add fire equipment to their portfolio. You will gain an understanding of all our products and their benefits. We will also discuss how they can be implemented within different on-site applications.



Technical Support

We're here to provide you with complete technical support across the country.

This includes:

- helping you choose the right alarm
- providing guidance on installation locations in accordance with British Standards, Building Regulations and local government recommendations
- guiding you through installation steps
- giving you tips for maintenance

We can assist you with detailing specification documents as well provide support when comes to design layouts and product selectivity.



CIBSE Member

Maintaining a competitive edge is vital to stay ahead in the fast moving professional electrical industry. Scolmore® Group has a wealth of CPD accredited training modules available to keep you up to date with the latest regulations, technologies, and product innovations.

Trusted Tech, UK Design

All Esquire® products undergo a meticulous design, development and manufacturing process at our dedicated factory. To ensure compliance with all relevant product standards, rigorous testing is conducted at various stages of production. Resourced with an experienced team and comprehensive testing equipment, our factory has produced over four million units.

RF-Link

To add additional life safety protection and installation flexibility, the alarms with the RF-Link function can be coded together wirelessly to create a system that sounds all alarms if one is activated. Mains powered alarms also include the function of hardwired interconnect.



Espire[®] Website

espireuk.com

Check out our website to view 'how to' videos, our alarm selection tool and comparison tables. We also offer online ordering and a marketing hub.



'How to' videos

Visit our website and YouTube channel to find a range of 'how to' videos - from alarm installation to pairing devices.



Alarm Selection

Our website's handy product finder page allows easy comparison of models to find the perfect fit for your project.



Alarm Comparison

View our range of alarms in interactive tables which allow you to compare models.

Contents

- 12 Standards
- 28 Alarm Sensor Types
- 40 Siting
- 50 Installation
- 76 Testing and Commissioning
- 82 Alarm Maintenance

Standards

Stay informed about the most recent laws and regulations.

Here is all the relevant information you should be aware of.



All installations should conform to the relevant British Standards including BS 7671, BS 5839-6 and BS 9991 where relevant.

CONTENTS

13	BS 5839-6
14	Building Regulations
15	Fire Risk Assessment
16	Grades of System
17	Categories of System
19	New Build (Owner)
20	New Build / Existing (Rented)
22	New Build / Existing (Supported Housing)
23	Existing (HMO 1-2 Storey)
24	Existing (HMO 3+ Storey)
25	Existing (Sheltered)
26	BS EN 50292
27	Priority Areas

BS 5839-6

Fire detection and fire alarm systems for buildings

BS 5839-6 is a code of practice for the design, installation, commissioning and maintenance of fire detection systems in dwellings. It covers new build and existing properties. This is to be used when designing, installing and commissioning fire detection and fire alarm systems in domestic premises.

BS 5839-6 differs from approved documents in terms of its purpose. Minimum requirements are detailed by approved documents (Building Regulations), whereas BS 5839-6 provides recommendation on design and installation.

The Building Regulations may make recommendations for new-build properties to legacy versions of BS 5839-6, however on application following the necessary guidance you will always work to the latest and most current published standard.

Building Regulations

England and Wales

Building Regulations Document B
Updated in 2019 replacing 2006 edition

Application;

- New build
 - Materially altered dwellings
 - Loft conversions
 - Certain building extensions
 - Change of use
-

Scotland

Technical Handbook 2022
Latest Publication 2nd December 2020

Continues to apply to;

- New build
 - Materially altered dwellings
 - Loft conversions
 - Certain building extensions
 - Any works which require a 'building warrant'
-

Northern Ireland

Technical Booklet E - 2012
Latest Publication 31st October 2012

- New build
- Materially altered dwellings
- Loft conversions
- Certain building extensions

Fire Risk Assessment

Commentary

A fire detection and alarm system, although unable to prevent fires, can mitigate injuries or property damage resulting from them. However, its effectiveness relies on occupants' ability to respond to warnings and use the evacuation time it provides. Thus, it should be viewed as just one aspect of a comprehensive fire safety strategy.

To optimise the cost-effectiveness of such a system, its design must align with the specific fire risks. For instance, a thorough understanding of fire risks in residential settings is crucial for designing systems compliant with standards like BS 5839.

Different levels of fire risk necessitate varying degrees of reliability and complexity in detection and warning systems. For example, while a single battery-powered smoke alarm may suffice for a small bungalow, a multi-storey house with multiple occupants may require a more sophisticated setup.

Therefore, system design considerations, including detector placement and power supply, should be based on probabilities such as the likelihood of fire occurrence, potential occupant injuries or fatalities, system reliability during emergencies, and the efficacy of early detection and warning mechanisms.



Recommendations

A fire detection and alarm system, in accordance with the guidelines outlined in this section of BS5839, ought to be implemented in every residential property, regardless of its age or status. The eventual design ought to, when feasible, derive from a fire risk assessment.

Grades

BS 5839-6 splits alarm systems into the following grades:

A A fire detection and fire alarm system, which incorporates control indicating equipment.

C A system of fire detectors and alarm sounders which may be combined units connected to a common power supply, comprising the normal mains and a standby supply, with central control equipment.

D1 A system of one or more mains-powered detectors, each with a tamper-proof standby battery.

heat
ES1HLV

smoke
ES1SLV

smoke & heat
ES1MULV

CO
ES1CLV

CO & heat
ES1CHLV

D2 A system of one or more mains-powered detectors, each with an integral standby supply consisting of a user-replaceable battery or batteries.

heat
ES1HRV

smoke
ES1SRV

F1 A system of one or more battery-powered detectors powered by a tamper-proof primary battery.

heat
ES1HL

smoke
ES1SL

smoke & heat
ES1MUL

CO
ES1CL

CO & heat
ES1CHL

Categories of System

OPTIMUM PROTECTION

Appropriate where occupants are likely to be vulnerable. In addition to LD2 recommendations, alarms are installed in all circulation areas and all rooms or areas in which a fire might start. Excludes toilets, bathrooms or shower rooms.

BASIC PROTECTION

In addition to the LD3 recommendations, alarms are installed in certain rooms determined by the risk assessment, e.g. a heat alarm is installed in each kitchen, or a smoke alarm installed in the principal habitable room. Excludes toilets, bathrooms or shower rooms.

MINIMUM PROTECTION

Alarms installed in all hallways, stairways and circulation areas that form part of the escape routes. All alarms are to be interconnected.

Alarm locations are to follow guidance provided in British Standard; BS 5839-6. A Fire Risk Assessment is used to determine the grade and category of system required.

LD1



LD2



LD3



New Build

Ensure that when multiple rooms serve as the primary living space, each of these rooms must have a smoke detector installed. However, exercise caution regarding possible false alarms if a kitchen is directly connected to or integrated with the living room.

Grade D2

Category LD2^D

Owner Occupied Single Storey Property

heat
ES1HRV

smoke
ES1SRV



Owner Occupied 2-3 Storey Property

heat
ES1HRV

smoke
ES1SRV



This information serves as a guide and is derived from Table 1 of BS 5839-6 for properties with a floor area not exceeding 200m². However, a fire risk assessment may warrant a different grade/category than the one mentioned here. For comprehensive details, please consult BS 5839-6.

New Build/Existing

Detectors may be omitted from attic spaces unless significant fire hazards are present, such as gas boilers or electrical components for photovoltaic systems.

Grade D1

Category LD1¹

Self Catering Accommodation and Supported Housing

heat
ES1HLV

smoke
ES1SLV



Properties hosting short-term paying guests

Accommodation for self-catering purposes

Supported housing with a maximum of 4 bedrooms



This information serves as a guide and is derived from Table 1 of BS 5839-6 for properties with a floor area not exceeding 200m². However, a fire risk assessment may warrant a different grade/category than the one mentioned here. For comprehensive details, please consult BS 5839-6.

New Build / Existing

Ensure that when multiple rooms serve as the primary living space, each of these rooms must have a smoke detector installed. However, exercise caution regarding possible false alarms if a kitchen is directly connected to or integrated with the living room.

Grade D1

Category LD2^D

heat
ES1HLV

smoke
ES1SLV



Rented Single Storey Property

smoke & heat
ES1MULV

CO & heat
ES1CHLV

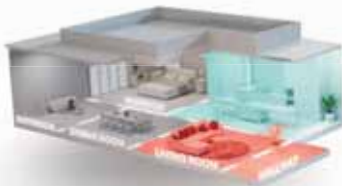

Smoke alarms in hallways and landings

Heat alarm in kitchen

Smoke alarm in habitable room(s)

heat
ES1HLV

smoke
ES1SLV



Rented 2 - 3 Storey Property

smoke & heat
ES1MULV

CO & heat
ES1CHLV



Existing

Detectors may be omitted from attic spaces unless significant fire hazards are present, such as gas boilers or electrical components for photovoltaic systems.

Ensure that when multiple rooms serve as the primary living space, each of these rooms has a smoke detector installed. However, exercise caution regarding possible false alarms if a kitchen is directly connected to or integrated with the living room.

HMO 1-2 Storey Property

Grade D1^J | Category LD2^D

heat
ES1HLV

smoke
ES1SLV

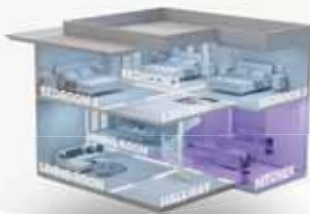

heat
ES1HLV

smoke & heat
ES1MULV

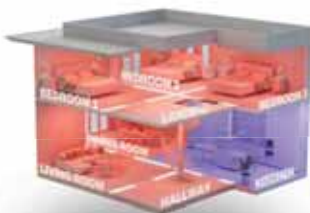

Smoke alarms in
hallways
and landings

Heat alarms
in kitchens

Smoke alarms in
habitable rooms

Detectors may be omitted from attic spaces unless significant fire hazards are present, such as gas boilers or electrical components for photovoltaic systems.

For bedsits equipped with cooking facilities, it is advisable to fit a heat or multi-sensor fire alarm. If opting for a multi-sensor alarm, having an alarm silence function would be advantageous.

HMO 3+ Storey Individual Dwelling

Grade D1 | Category LD2^{JN}

smoke & heat
ES1MULV



HMO 3+ Storey Communal Area

Grade A
Category LD2

smoke
ES1SLV



This information serves as a guide and is derived from Table 1 of BS 5839-6 for properties with a floor area not exceeding 200m². However, a fire risk assessment may warrant a different grade/category than the one mentioned here. For comprehensive details, please consult BS 5839-6.

Existing

When renovating sheltered housing and conducting electrical tasks such as rewiring or updating smoke alarms, it's advisable to incorporate a Grade D (D1 or D2) category LD1 system.

Sheltered Property

Grade A - Communal Area

In accordance with the recommendations of BS 5839-1:2017 for a Category L4 or L5 system R)

Grade D2 - Individual Dwelling



smoke
ES1SRV



This information serves as a guide and is derived from Table 1 of BS 5839-6 for properties with a floor area not exceeding 200m². However, a fire risk assessment may warrant a different grade/category than the one mentioned here. For comprehensive details, please consult BS 5839-6.

BS EN 50292

Electrical apparatus for the detection of carbon monoxide in domestic premises, caravans and boats.

This particular British Standard corresponds to the adoption of BS EN 50292 within the UK.

The standard serves as a helpful reference for selecting, installing, using, and maintaining devices designed to detect carbon monoxide in domestic homes, caravans, and boats.

It is complemented by EN 50291-1 and EN 50291-2, which are the performance standards for carbon monoxide alarms in residential settings, as well as EN 50291-2, specifically addressing the installation of carbon monoxide alarms in caravans, motor homes, and recreational craft.

Recent studies have demonstrated that carbon monoxide (CO) released, for example, in a boiler room, can disperse not only through open spaces like cable ducts, door sills, or keyholes, but also permeate through walls and ceilings throughout the entire building.

The rate of permeation varies depending on the building materials employed, such as wood, brick, concrete, plasterboard, etc., and cannot be precisely determined in general.

Hence, it is strongly advised that, at the very least, each room housing a fuel-burning device should be equipped with a detection device capable of promptly identifying any significant exposure to CO. Ideally, each sleeping room and those distant rooms where people spend a lot of time when awake, should also be equipped with a detection device.

Priority Areas

If you have fuel-burning devices or only a few CO alarms, focus on these important areas:

Install alarms in rooms with flueless or open-flued appliances.

Install alarms in rooms where occupants spend the most time.

Here are some examples of appliances without chimneys or with open vents:

Gas
stoves

Gas
fireplaces

Boilers with
open vents

Furthermore, according to BS EN 50292, it is recommended to protect flues in cases where a fuel-burning device has a hidden or extended flue. Install a device in each room that the flue passes through.

Other Regs

Carbon Monoxide

Document J - England and Wales

Technical Handbook - Environment - Scotland

Technical Booklet L - Northern Ireland

Alarm Sensor Types

What types of protection do you require?

Explore the wide variety of sensor options offered within Espire's comprehensive selection of fire and carbon monoxide protection products.

Uncover the various types of sensors available and choose the perfect fit for your needs.



Ensuring the appropriate sensor is properly installed will provide optimal protection while minimizing false alarms.

CONTENTS

29	Smoke Alarms
31	Heat Alarms
33	Smoke & Heat Alarms
35	Carbon Monoxide Alarms
37	Carbon Monoxide and Heat Alarms
39	Alarm Features

Smoke



Products:

- ES1SLV Powered by mains with a sealed 10 year lithium battery
- ES1SRV Powered by mains with a replaceable 9V battery
- ES1SL Powered by a sealed 10 year lithium battery



Features:

EN14604 smoke alarm devices

Identifies the dispersion of light caused by smoke particles

Utilises an Infrared LED and receiver for operation

When smoke enters, the scattered light falls onto the receiver, triggering the alarm.

Test Fires Category

Our smoke alarms can be classified into the following categories.

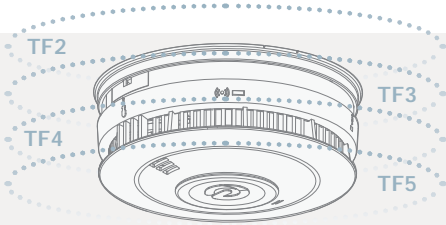

TF2 smouldering wood, TF3 smouldering cotton, TF4 flaming plastic, TF5 flaming liquid (heptane).



Living Areas



Bedrooms



Escape Routes



Stairways

Heat

5YR
Warranty

Products:

ES1HLV Powered by mains with a sealed 10 year lithium battery

ES1HRV Powered by mains with a replaceable 9V battery

ES1HL Powered by a sealed 10 year lithium battery



Responsive to heat alone with the advantage of minimizing false alarms.

Features:

BS 5446-2 specification for heat alarms

Single sensor alarm

Thermistor sensor responds to high temperatures

Alarm set point to trigger at 58°C

Only responds to heat, not smoke

Suitable for kitchen areas which produce fumes, (toasting, grilling, frying etc).

Test Fires Category

Our heat alarms can be classified into the following categories.

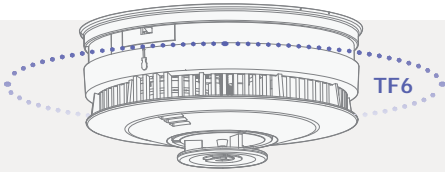

TF6 flaming liquid (methylated spirit).



Kitchen Areas



Garages

Smoke & Heat

5YR
Warranty

Products:

ES1MULV Powered by mains with a sealed 10 year lithium battery

ES1MUL Powered by a sealed 10 year lithium battery



Features:

EN14604 smoke alarm devices,
BS 5446-2 specification for heat alarms

The combination of both smoke and heat sensor
ensures the broadest fire detection coverage

Intelligent software continuously monitors
both sensors at all times.

Test Fires Category

Our smoke and heat alarms can be classified into the following categories.

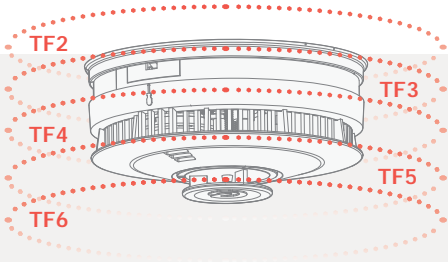

TF2 smouldering wood, TF3 smouldering cotton, TF4 flaming plastic, TF5 flaming liquid (heptane), TF6 flaming liquid (methylated spirit)

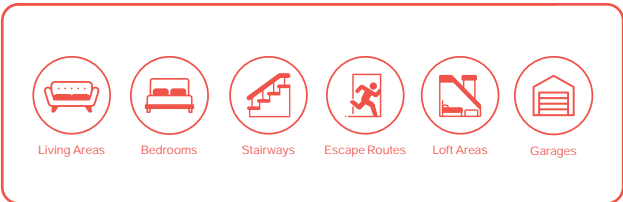

Carbon monoxide

5YR
Warranty

Products:

ES1CLV Powered by mains with a sealed 10 year lithium battery

ES1CL Powered by a sealed 10 year lithium battery



Features:

EN 50291-1 gas detectors

Identifies the presence of carbon monoxide (CO) gas emitted by the combustion of carbon-based fuels such as gas, wood, oil, and coal

An interaction between CO gas and acid takes place within the sensor, resulting in the generation of electric current

The magnitude of the electric current generated is directly proportional to the level of CO present.

Carbon Monoxide Poisoning Table

PPM of CO	Typical Symptoms
100	Headache, sickness, nausea, fatigue and flu-like symptoms
200	Dizziness and headache within 2 to 3 hours
400	Nausea, frontal headache, drowsiness, confusion and rapid heart rate. Risk to life after over 3 hours of exposure
800	Severe headaches, convulsions, vital organ failures. Death possible within 2-3 hours.



Kitchen Areas



Fuel Burning Areas

CO gas is both invisible and odourless, making it unnoticeable to our senses. To safeguard yourself from this potential danger, it is crucial to install a CO alarm.

CO & Heat

5YR
Warranty

Products:

ES1CHLV Powered by mains with a sealed 10 year lithium battery

ES1CHL Powered by a sealed 10 year lithium battery



Features:

EN 50291-1 gas detectors,
BS 5446-2 specification for heat alarms

Utilises two distinct sensors to monitor both fire
and carbon monoxide (CO) independently

Intelligent software continuously monitors
both sensors at all times

Suitable for kitchen areas which produce
fumes, (toasting, grilling, frying etc).

Test Fires Category

Our carbon monoxide and heat alarms can be classified into the following categories.

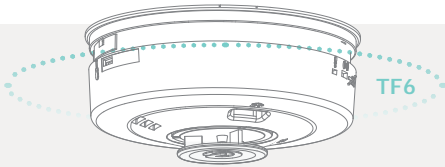

TF6 flaming liquid (methylated spirit).



Kitchen Areas



Fuel Burning Areas

CO gas is both invisible and odorless, making it unnoticeable to our senses. To safeguard yourself from this potential danger, it is crucial to install a CO alarm.

Unique to Espire®

Auto Dim LED Status Light

With mains powered alarms, when the power LED is required to remain on, the LED will automatically dim during low light levels to reduce distraction and not disturb sleep.



Auto Dim LED



PATENT PENDING

Stainless Steel Insect Mesh Barrier

Reduces false alarms by protecting the smoke chamber from insects and debris.



RF-Link
(Optional)

RF-Link

To add additional life safety protection and installation flexibility, compatible Espire® alarms can be installed with the RF-Link module. The RF-Link function enables alarms to wirelessly connect to create a system that will sound together if one alarm is activated, increasing protection.

Siting

Where should our alarm systems be positioned?

Correct placement of Espire® alarms is crucial for prompt response. This section will provide guidance to assist you during the installation process.



Correct positioning alarms is vital to ensure that smoke, heat, or carbon monoxide (CO) can reach the alarm promptly. This ensures the alarm can quickly detect any potential hazards and alert you effectively.

CONTENTS

41	Hallways, Landings & Stairways
42	Smoke & Heat Alarms
43	Peaked Ceilings
44	Sloped Ceilings
45	Beams
46	Rooms with Appliances
47	Rooms without an Appliance
48	Restricted Spaces

Hallways, Landings & Stairways

Site an alarm, centrally on the ceiling in the ground floor hallway. Site an alarm, centrally on the ceiling on all subsequent floors (landings).

All the previous siting recommendations will apply – max of 7.5m to an alarm, an

alarm within 3m of all bedroom doors and keep alarms away from areas where false alarms may occur e.g. Kitchens and Bathrooms.

Do not site alarms on the wall or any sloping parts of the ceiling (unless there are no flat parts).



Centrally on the ceiling
not on the sloping stairway

**300mm clearance gap
surrounding the alarm**
away from obstructions / light fittings

Smoke & Heat Alarms



5.3m
detection radius
heat

7.5m
detection radius
smoke & heat



Within 3m of bedroom doors

**Positioned away from the
bathroom door**

**Circulation space between
high risk rooms**
i.e. living room, kitchen

Peaked Ceilings

The BS 5839-6 British Standard recommends that smoke alarms should be sited so their sensing elements are between 25mm and 600mm below the ceiling.

Where the ceiling is pitched, the smoke alarm should be installed at, or not more than, 600mm vertically below the apex.

In the case of heat alarms the BS 5839-6 British Standard recommends that the sensitive element should be located between 25mm and 150mm below the ceiling.

Where the ceiling is pitched, the heat alarm should be installed at 150mm vertically below the apex.



**Heat alarm
<150mm**

**Smoke alarm
<600mm**

Sloped Ceilings

In the case of a sloping ceiling the recommendations on the previous page apply with the exception that if the vertical distance between the peak and the eaves is less than 600mm the ceiling should be treated as flat.



**300mm clearance gap
surrounding the alarm**

away from obstructions / light fittings / dead airspace

<600mm treat as flat ceiling

Beams

It is also important to follow the siting recommendations covered in the previous pages where they are applicable to the installation.

Roof beam is <10% of room height

Mount distance from the beam, 2 x the depth of the beam or 500mm.



Roof beam is >10% of room height

Treat as a wall / partition mount detectors should be installed on both sides of the beam or, if the beam is less than 600mm in depth, a detector should be installed on the underside of the beam.

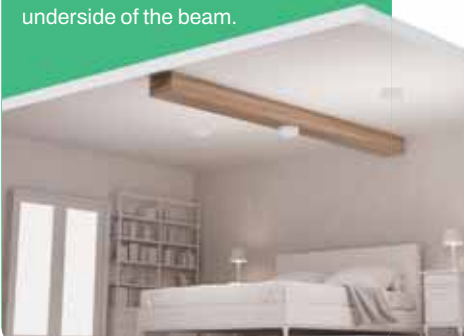

Rooms with an appliance

Alarms should be sited:

- In the same room and within 1-3m of the appliance or CO producing equipment
- Open flued / flueless appliance
- Most common used areas

Not within:

- An enclosed cupboard <1m³
- Bathroom
- Rooms with concealed flues passing through voids



**1-3m from
appliance**

**150mm from ceiling
if wall mounted**

**300mm clearance gap
surrounding the alarm**

away from obstructions / light fittings / dead airspace

Rooms without an appliance with flue and void

In a room without an appliance the CO alarm should be mounted within the breathing zone. This is because the CO is not being heated by an appliance and therefore not rising up towards the ceiling.

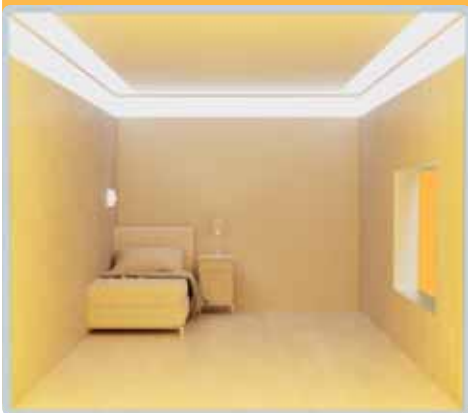

Wall mounted close to breathing zone

Restricted spaces

Definition of dead air space: the area, approximately 300mm deep from walls and other solid objects where the air does not move to any extent. This means that smoke does not move very much in these areas either, so alarms should not be sited in them because they will be slow to respond to smoke.

The ideal position for a smoke alarm is in the centre of the area to be protected (hallway, landing or room).

Restricted Spaces



Must site clear of dead air spaces in corners

300mm clearance gap surrounding the alarm
away from obstructions / light fittings / dead airspace

Installation

Everything you need to know about installing an Espire® alarm system.

With its advanced features, Espire® alarms ensure a simplified installation process, offering wireless linking and other convenient functionalities.



The RF Link wireless interconnection feature saves time, reduces mess, and minimises disruption during installation, eliminating the need for interconnect cables.

CONTENTS

51	Alarm Installation
52	Which Circuit - Grade D
53	Power Supply
54	Wiring Connections
55	Wiring Diagrams
57	Espire® Alarm Installation
59	Hardwired Installation
61	Interconnected Wiring Installation
62	Incorrect Wiring
63	RF-Link
65	RF-Link & Interconnection
67	RF-Link Installation
69	RF-Link Coding
71	RF-Link Alarm Controller
73	Wired Relay Base
75	Unique Features

Alarm Installation

All mains powered Esquire® alarms are complete with an easy to install lock-in wiring base.

Install base

Fit the mounting base to the ceiling in the required position – the mounting base has a removable trunking door for use when surface trunking is being used.

There is no requirement for an additional mounting pattress or dry lining box. Install the alarm, or leave until all decorating and cleaning up has taken place.

Connect and test cables

Feed the cables from the ceiling void, or via trunking and wire up to the terminals in the mounting base. The terminals are designed to take 3 x 1.5mm² cables or 3 x 1.0mm² cables.

Slide on alarm

Clip the wiring cover into place and the installation is electrically safe. Install the alarm, or leave until all decorating and cleaning up has taken place. If it is necessary to fit the alarm before all the other work has been completed, fit the dust cover supplied with the alarm securely to keep dust and other contamination out of it.

Which Circuit – Grade D

Clause 15.4 of BS 5839-6

The following recommendations should be met:

The mains electrical supply for smoke heat alarms should take the form of either:

1

An independent circuit at the dwelling's consumer unit, i.e. no other electrical equipment should be connected to this circuit.

2

A separate electrically protected, regularly used local lighting circuit.

Power Supply

Clause 15.4 – Power Supply Grade D Why we recommend the lighting circuit.

In some housing, tenants/owners are likely to try to save energy by switching devices off. They are less likely to turn off the lighting circuit than a smoke alarm circuit.

BS5839-6 recommends that there should be a means of isolating the smoke alarms from the lighting circuit.

We use a fixed base for the electrical connections. The Esquire® alarm can be readily removed by use of a tool operated release tab.



Insert
release tool
or flat head
screwdriver

Press
release tab

Slide alarm
off its base

Wiring Connections

Where use is made of three-core and CPC as a means of connecting alarms with an interlink, use the following:



BROWN

Line Connection.
(Phase)



GREY SLEEVED BLUE AT EITHER END

Neutral Connection.



BLACK

Interconnect Connection.



SLEEVED GREEN / YELLOW

CPC Connection.

Whilst the alarm is an item of Class II equipment, the wiring must still conform to the requirements for BS 7671 and so an earth connection is provided in each alarm.



Cable colours are visual representations and would need to be identified correctly in accordance with the BS 7671 and other related standards.

Wiring Diagrams

For hardwired alarms

Smoke and CO Alarms - Hardwired

To first alarm: 2 core PVC.
Between alarms: 3 core PVC.

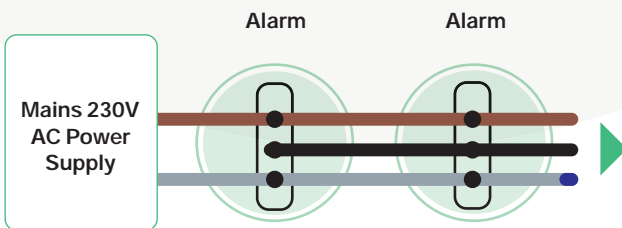

Smoke and CO Alarms - RF-Link

To each alarm: 2 core PVC.

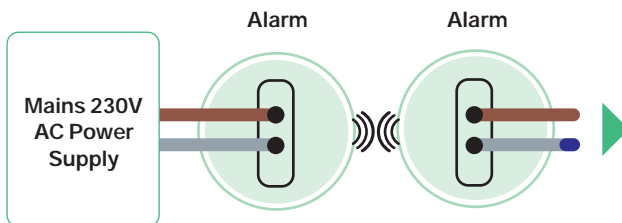

Relay Base with RF-Link Alarms

Power to relay base: 2 core PVC.
Between relay base and alarm : 3 core PVC.

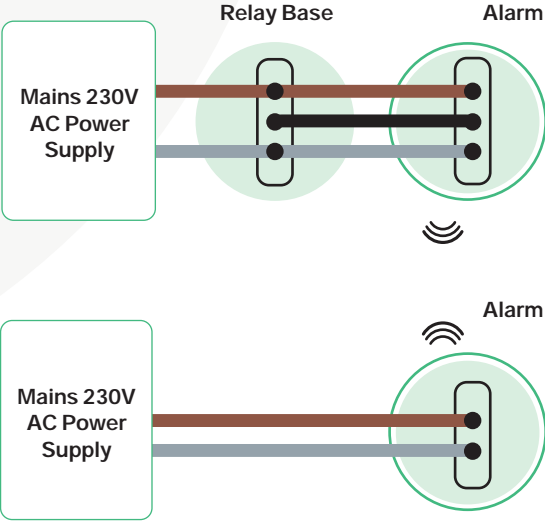

Alarm and RF Link Remote Controller

To each alarm: 2 core PVC.

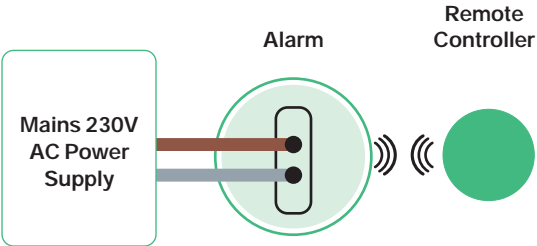

Alarm Installation

Alarm installations are to follow guidance provided in British Standard; BS 5839-6 and BS EN 50292 where relevant. For optimum performance the preferred location for the alarm is a central ceiling position, and at least 300mm from walls and any objects such as light fittings. It should be mounted on a flat surface, with no obstructions such as existing pipes or wiring. Avoid the following locations: sources of high humidity, condensation or steam, such as bathrooms and shower rooms; close to sources of heat or cool air which cause sudden temperature fluctuations.

Vaulted/Sloped Ceiling Positioning

- Position smoke and multi-sensor alarm within 600mm of the peak.
- Position heat alarms with in 150mm of the peak.



Ceiling Positioning

- Alarm to be ceiling mounted in the centre of the room
- Alarm to be positioned 300mm (min) away from walls and obstructions, i.e. light fittings.

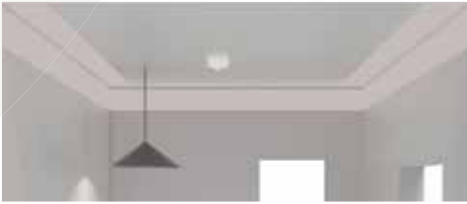

Room with Appliance Positioning

- Position alarm 300mm (min) away from walls and obstructions, i.e. light fittings.
- Mount alarm between 1m and 3m away from the appliance.
- If there is no fuel burning appliance in the room, mount at breathing height.



*ES1CHLV is not suitable for wall mounting
ES1CLV can be wall mounted at least 150mm from
the ceiling and higher than windows and doors.*

Hardwired Installation

Hardwired interconnect

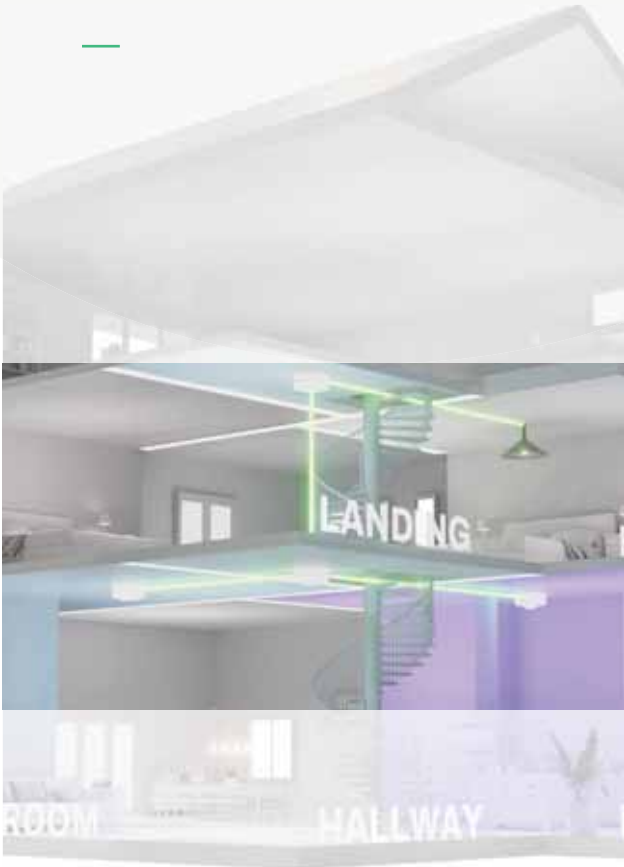

230V mains supply taken from a lighting circuit (permanent supply).

Hardwired interconnect dedicated circuit

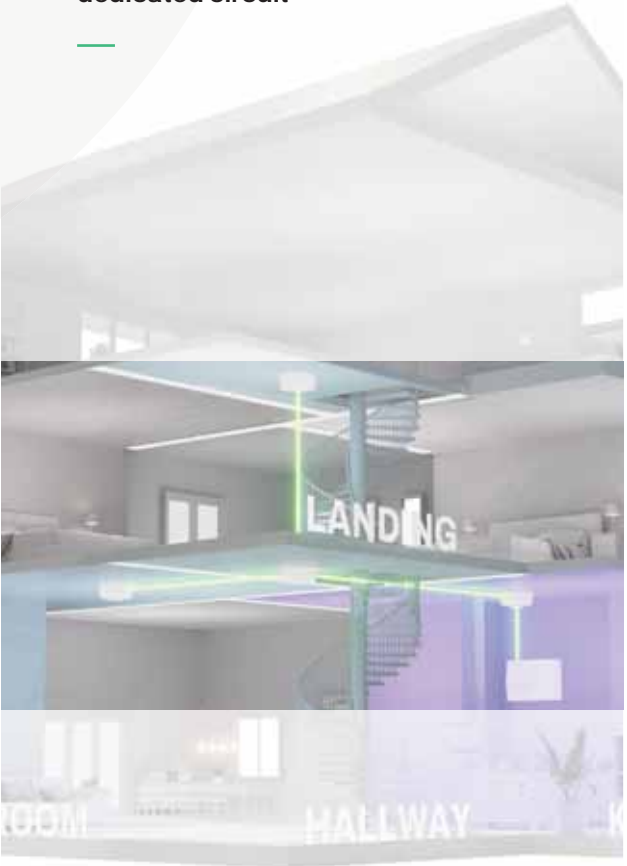

230V mains supply taken
from a consumer unit.

Interconnected Wiring Installation

A maximum of 28 alarms can be interconnected.

In the event of an alarm activation all alarms will trigger the sounder. The alarm that triggered the activation will display the red LED.

Do not connect Esquire® alarms to any other type of alarm produced by another manufacturer.

Using the incorrect wiring connections is likely to damage all the alarms connected to the system.

The interconnect wire (minimum 1mm² cable) should be insulated and sheathed. A maximum of 300 metres of wire can be used for the total length of the circuit.

Heat alarms must always be interconnected to a smoke or multi-sensor alarm to ensure early warning.

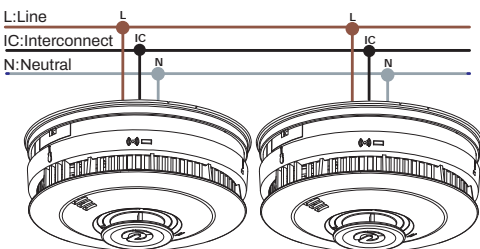

If only one CO alarm is installed, audibility could be a problem. Where more than one CO alarm is installed they should be interconnected.

Incorrect Wiring

It is important that the alarms are connected as described by the manufacturer.

Incorrect connections may cause damage to the alarm, and all attached alarms when in operation. Furthermore, incorrect connections may cause the alarm(s) to fail to operate as required under fire conditions.

Prior to powering up check all connections in each alarm and carry out all necessary tests as described by BS 7671 and BS 5839-6.

After confirmation of correct connection and suitable test results, power up and confirm operation of each alarm by pressing the test button.

- Ensure the wiring diagrams are followed.
- If the alarm is mains powered, ensure the green power LED is permanently on.
- If Interconnected, check all alarms sound during testing.
- Test all alarms on the system.



Incorrectly wiring one alarm will damage all the alarms in the system

RF-Link

Prior to RF coding, ensure that all system alarms are correctly wired, powered and functioning independently. Ensure the alarms have been fitted with

the RF-Link module. Up to 28 alarms can be interconnected wirelessly via the RF-Link function. The maximum distance between the alarms is 100m (free space).

The RF status LED is located on the side of the alarm, marked with an RF symbol.



The RF coding switch is located on the side of the alarm, marked with the tool symbol.

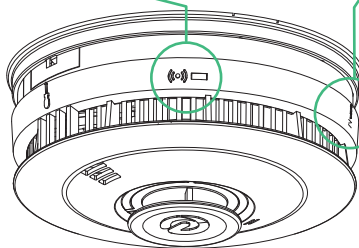

LED Off:
Normal Status

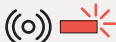

Red Flashing LED:
Primary Alarm

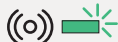

Green Flashing LED:
Successful Coding



**Easier to upgrade to
wireless interconnection**

**Greater flexibility in
extending systems**

RF-Link & Interconnection

A simple, convenient means of interconnecting a Grade D alarm system without cables.

Reduces installation time

Reduces mess and disruption

Simple wiring

Battery powered alarms also have the RF - Link facility and do not require wiring.

RF signals link between the alarms

Power supply is required to each unit.

RF-Link alarms can be connected to a lighting circuit:

- The alarms are wired using 2 core cable.
- If using RF-Link enabled alarms do not connect the IC wiring terminal.
- Any lighting circuit can be used to make the connection.
- The lighting circuit used must have a permanent live connection. Using a switched line connection can cause problems with the charging circuit on the RF-Link units.



If smoke alarms and heat alarms are capable of being interconnected through wiring, all smoke and heat alarms should be linked on one unified circuit.

This suggestion is not relevant if the method of interconnection cannot conduct electricity. If the interconnection relies on radio communication instead of wiring, RF-Link systems can be connected to a nearby lighting circuit.

Many people are confused by this clause in BS 5839-6 and think that Grade D smoke and heat alarm systems can only be installed on a single final circuit. Whilst this is a recommendation of the standard, there may be a time where you would have a mixture of hardwired and RF interconnected alarms on one system. For example where physically impossible to run an interconnection from one part of the property to an extended part of the property.

RF-Link Installation

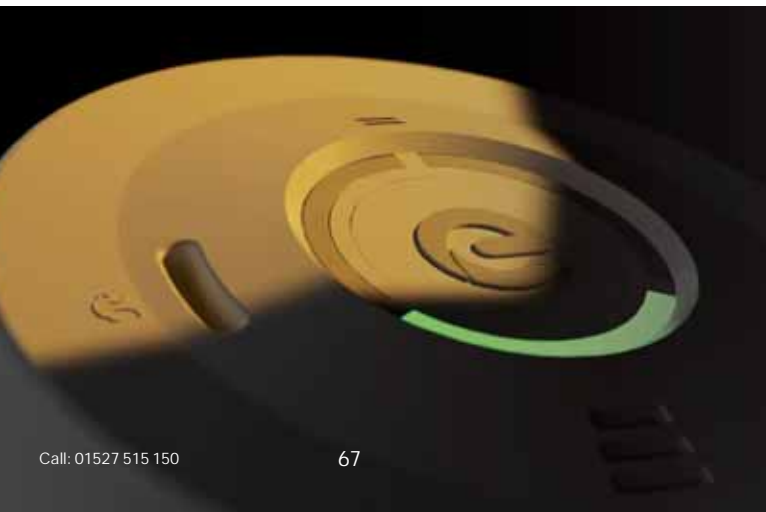

The diagram shows a very common installation – alarms installed on the ground floor and an additional alarm installed on the first floor.

Wire from a convenient light circuit – permanent live supply required.

No cables between the alarms – a radio signal works in both directions to send an interconnect signal when an alarm is activated.

This means that if any of the ground floor alarms operate due to a fire (or test on the Test and Hush button) they will send out a radio signal and the alarm on the first floor will receive the signal and also sound – in the same way that a hard-wired system would operate. If the alarm on the first floor operates due to a fire (or test on the Test/Hush button) the signal will be sent in the opposite direction and the ground floor alarms will all also sound.

RF-Link signals interconnect alarms

230V mains supply taken locally from lighting circuit

Battery powered alarms have the RF-Link facility and do not require mains supply

RF-Link Coding

As default, the RF-Link modules are universally coded together. It is important to carry out the alarm RF coding procedure to ensure the system operates independently from other nearby Esquire® alarm systems.

Step 1

Using the supplied pairing tool press and hold the RF coding switch on one of the system's alarms for a minimum of 3 seconds and release when the RF status LED flashes red.

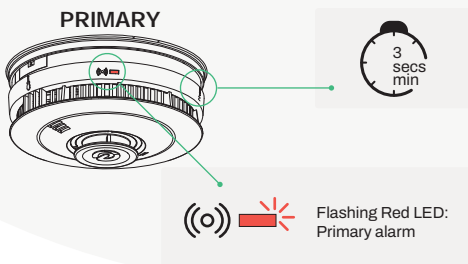

Step 2

While the **primary** alarm is in coding mode, at the next alarm press the RF coding switch 3 times and the RF status LED will turn green to confirm successful coding. Repeat the process on the remaining alarms. RF coding mode will be active for 30 minutes before auto time out.

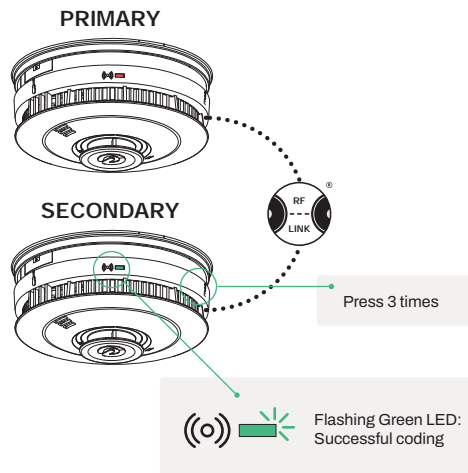



Use the pairing tool (supplied with RF modules) to assist with coding setup.

Step 3

Once all the alarms have been coded to the **primary** alarm, return to the **primary** alarm and single press the RF coding switch once, the RF status LED will stop flashing. RF coding mode has now ended.

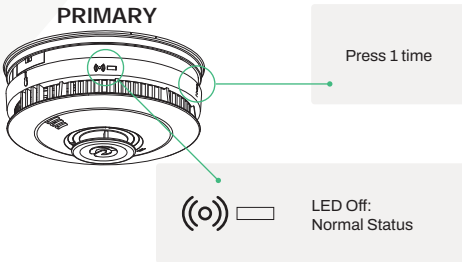

Step 4

After coding is completed, test each individual alarm and check that all interconnected alarms trigger the sounder. There may be up to a 10 second delay for the coded alarms to respond after pressing the test/hush button.

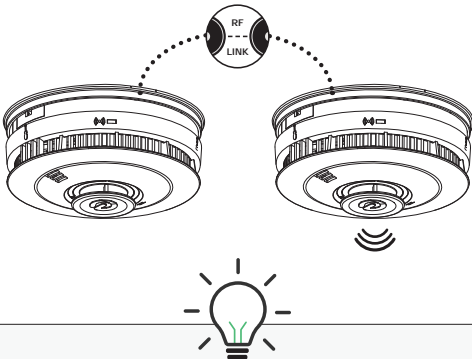

The first alarm that enters RF coding mode will be assigned as the 'primary', all other alarms will be assigned as a 'secondary'. It is important to mark the primary alarm with the label provided for future servicing of the system.

RF-Link Alarm Controller

ES1REM



The alarm RF-Link Remote Controller is unique in that it can be used with RF-Link alarms and provides some valuable features:



- Completely wireless, powered for life by a lithium battery.
- Attractive design makes it acceptable for siting anywhere in a property.
- Simple button controls all functions to avoid confusion.
- Can be used with RF-Link enabled smoke, heat and multi-sensor fire alarms and carbon monoxide alarms. An icon will show on the cover to indicate which alarm (fire or CO) has activated.

Fire and CO indicator to easily identify source of alarm

10 year lithium battery

Engineers mode for interrogation: holds memory of alarm activation

Test, locate source and silence

The controller has 4 important and useful functions:

TEST

Press the test button to test all the alarms in the system. Saves having to reach up to each alarm individually.



LOCATE

If the alarms are sounding, press the select button to identify which alarm is causing them all to sound, the other alarms will stop sounding.



SILENCE

If you are sure there is a false alarm, press the select button twice to silence the remaining alarm.



MEMORY

It is possible to determine if there has previously been an alarm state in the property.



The RF-Link controller must be set as the 'primary' device during system coding.

Also available...

ES1REMV: Hardwired remote control

Wired Relay Base with Back-up Battery

ES1RBRF: Hardwired with RF-Link option

ES1RB: Hardwired option

ES1MODV: Input hardwired option



Use the Espire® relay to trigger:

- Door opener/closer
- Panel system
- Smoke vent
- Gas shut down valve
- Warden call/telecare system
- Auto-dialer
- Strobe light
- Sounder
- Alarm systems
- GSM dialer
- Integration to fire alarm panel
- Fire door release mechanism

Activate Smoke Extractor

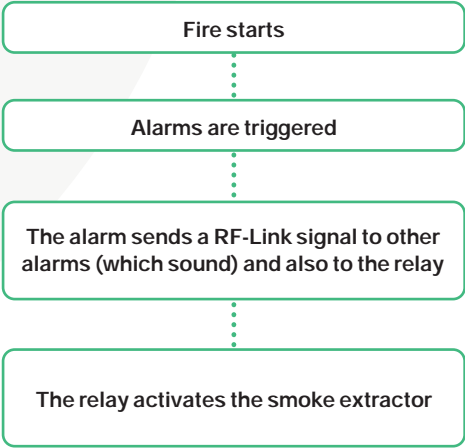

Smoke Extractor

Relay Module

Innovation at your fingertips

Faster smoke responses

Our intelligent system makes smoke detection much quicker, keeping you safe and saving lives.



Auto dim LED status light

With mains powered alarms, when the power LED is required to remain on, the LED will automatically dim during low light levels to reduce distraction and not disturb sleep.



Testing and Commissioning

Test the Espire® alarm after installation, and then weekly thereafter.

Check each individual alarm on the system is operating correctly, and that any other connected devices are operating as expected.

CONTENTS

78	Testing in Smoke
79	Grade D
80	Certification
81	Testing our Alarms



Testing in smoke

Pressing the test/hush button initiates a chamber test by increasing the light receptor in the sensor by x 20.

This means that the light shining back from the chamber bottom (backscatter), which it previously could not 'see', is now picked up by the receptor and the alarm will respond.

This is equivalent to smoke being in the sensor chamber.

As every alarm is tested with 'smoke' at the factory during production and at final assembly stage prior to dispatch, there should be no concern the smoke entry slots will be blocked.

It is recommended the full test and commissioning procedure should be carried out, not just rely on a button test of the alarm.

Commissioning Grade D

BS 5839-6 recommends the following when commissioning a system:

Any new wiring should conform to the requirements of BS 7671 and be inspected and tested accordingly. Do not undertake this test with any of the alarms connected to the wiring, as they will be damaged.

The functional test of the entire system should be carried out.

Complete a commissioning certificate giving information on the type of system installed.

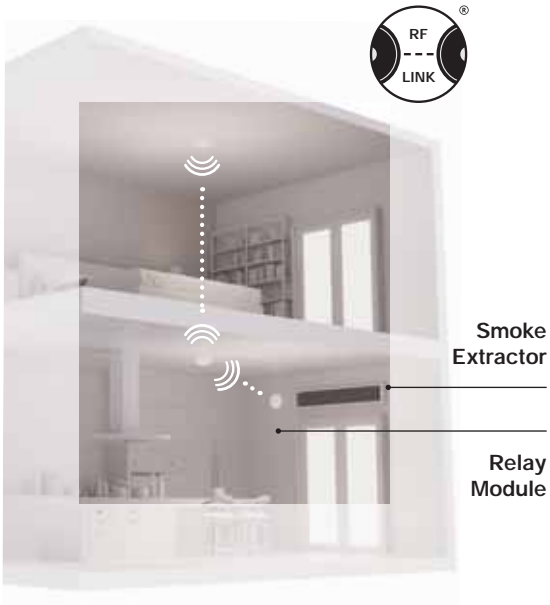

Commissioning Certification

There is sample certificate produced in the Annex of the BS 5839-6 standard. Most Electrical Associations have a similar certificate that can be used, if preferred.

The information required is fairly basic:

1. Address of property.
2. The grade of system installed.
3. The category of system installed.
4. If a smoke test has not been carried out, it is acceptable to enter a 'variation' from the recommendations of the standard.
5. Sign and date the certificate.



**Download the
Espire® installation
certificate here**



**Download the
Espire® servicing
certificate here**



Testing Espire® Alarms

Step 1

Press and hold the test/hush button for a minimum of 10 seconds.

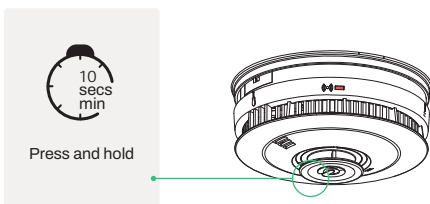

Step 2

The alarm will sound and the red LED will flash, indicating that the unit is working.

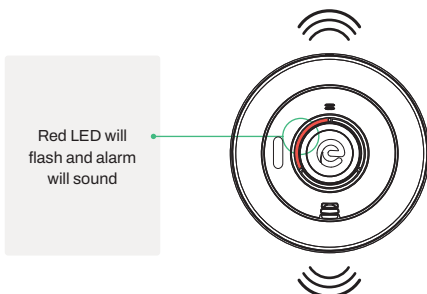

Alarm Maintenance

Alarm Cleaning

To avoid false alarms, clean the alarm regularly to avoid debris build up from dust and insects. In dusty areas it may be necessary to clean the alarm more frequently. Use a vacuum to remove dust build up and clean with a damp cloth, do not use cleaning products. Dry the alarm thoroughly after cleaning.



Our insect mesh barrier reduces false alarms in our smoke alarms by protecting the smoke chamber from insects and debris.

CONTENTS

- 83 Alarm Status Indication
- 85 Fault Finding

Alarm Status Indication

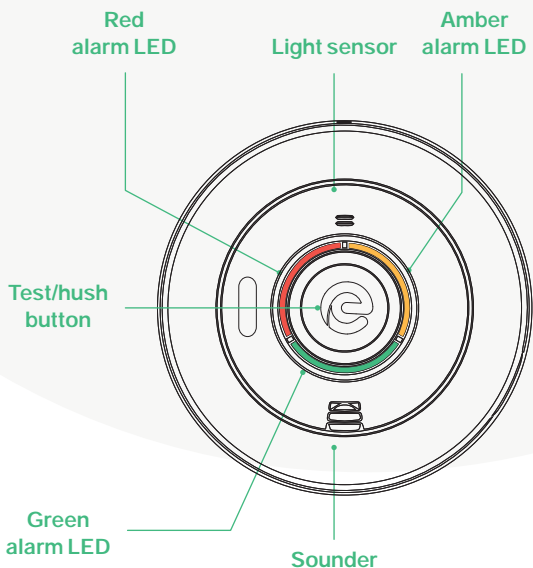

Example product label

Model number and sensor type

Manufacturing date code

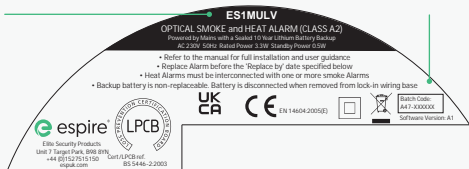

Replace by date

REPLACE ALARM BY: Apr 2034
 Manufacture:XX.XX.XXXX
 CODE:ES1MULV S/N:XXXXXX

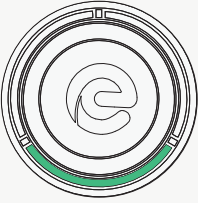

Power Indicator

Permanently on for mains powered alarms (not for battery only powered alarms).



Status/Fault Indicator

- Battery Fault
- Sensor Fault
- Smoke Chamber Contamination
- Alarm End of Life Reached
- Hushed Fault

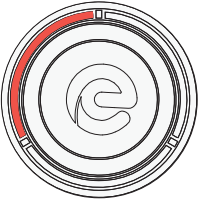

Alarm Indicator

- Activated Alarm
- Activation Stored in Memory
- Hush Function Activated
- Auto Test Check



The Auto Dim LED function automatically adjusts the brightness of the green LED in low light conditions, such as at night, to reduce distraction and not disturb sleep.

Fault Finding



Please see Esquire® product instruction manuals for product specific fault finding.



Normal Mode

A steady green LED means that the power supply to the alarm is normal.

For battery only models the green LED will not be permanently on. The auto dim LED function automatically adjusts the brightness of the green LED in low light conditions, such as at night, to reduce distraction and not disturb sleep.



Contamination Mode

Amber LED flashes 4 times to indicate the alarm's optical smoke chamber is contaminated.

Dust is one of the main causes, alarm cleaning and maintenance must be completed regularly.



Alarm Activation Mode



Red LED flashes and alarm sounds indicating the alarm has been activated.

If there is any doubt about the cause of an alarm activation assume it was caused by an actual fire and evacuate immediately.



Hush Mode

Red LED flashes every 8 seconds, indicating hush mode - sensor remains in activated state.

During an alarm activation if the 'Test/Hush' button is pressed the alarm will enter hush mode for 10 minutes before returning automatically to normal state.



Fault Mode



The amber LED flashes along with the alarm sounding in a sequence to indicate the alarm has a fault.

Please refer to the instruction manual for product specific fault finding.



Fault Hush Mode



The amber flashes in a sequence without the alarm sounding to indicate the alarm has a fault.

Low battery fault and end of life fault can be hushed more than once. Sensor fault can only be hushed once.



Memory Mode

Red LED flashes in a sequence indicating the alarm has stored a specific activation in the memory.

Memory function assists identification of alarms that have been activated. The memory will automatically clear after 24 hours of the activation, alternatively press and hold the 'Test/Hush' button until the red LED flashes twice and the alarm sounds twice.



**your safety,
our priority.**



ESP
Unit 7, Target Park,
Shawbank Road, Lakeside,
Redditch B98 8YN
Tel: +44 (0) 1527 51 51 50
Fax: +44 (0) 1527 51 51 43

sales@espuk.com
espuk.com

ESP Ireland
Unit 1B, Three Rock Road,
Sandyford Industrial Estate,
Dublin, Ireland
Tel: +353 (1) 5577 290
Fax: +353 (1) 2811 224

sales@espi.ie
espi.ie

E&OE - Errors and omissions excepted.

MAR-ESPIREGB - Contractors' Guidebook Issue 1